



# basic education

Department:  
Basic Education  
**REPUBLIC OF SOUTH AFRICA**

## NATIONAL SENIOR CERTIFICATE

GRADE 12

**ELECTRICAL TECHNOLOGY: DIGITAL ELECTRONICS**

**NOVEMBER 2023**

**MARKING GUIDELINES**

**MARKS: 200**

1. DBE IM: EM Mokwana
2. DBE IM: LM Shibambo

02/12/2023

3. Umalusi External Moderator

02/12/2023

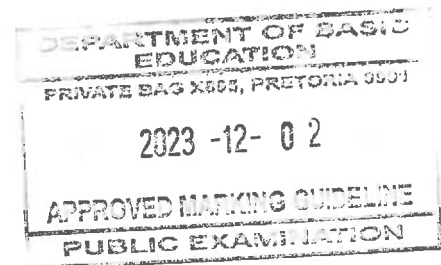

**These marking guidelines consist of 17 pages.**

**INSTRUCTIONS TO THE MARKERS**

1. All questions with multiple answers imply that any relevant, acceptable answer should be considered.
2. Calculations:
  - 2.1 All calculations must show the formulae.
  - 2.2 Substitution of values must be done correctly.
  - 2.3 All answers **MUST** contain the correct unit to be considered.
  - 2.4 Alternative methods must be considered, provided that the correct answer is obtained.
  - 2.5 Where an incorrect answer could be carried over to the next step, the first answer will be deemed incorrect. However, should the incorrect answer be carried over correctly, the marker has to re-calculate the values, using the incorrect answer from the first calculation. If correctly used, the candidate should receive the full marks for subsequent calculations.
3. This memorandum is only a guide with model answers. Alternative interpretations must be considered and marked on merit. However, this principle should be applied consistently throughout the marking session at ALL marking centres.

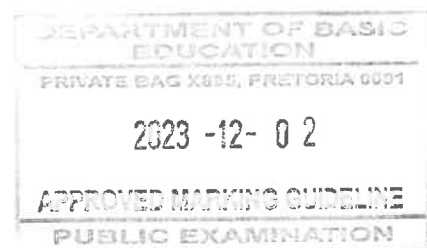

**QUESTION 1: MULTIPLE CHOICE**

- 1.1 C / D ✓ (1)
- 1.2 A ✓ (1)
- 1.3 C ✓ (1)
- 1.4 B ✓ (1)
- 1.5 A ✓ (1)
- 1.6 C ✓ (1)
- 1.7 A ✓ (1)
- 1.8 C ✓ (1)
- 1.9 C ✓ (1)
- 1.10 A ✓ (1)
- 1.11 B ✓ (1)
- 1.12 D ✓ (1)
- 1.13 D ✓ (1)
- 1.14 A ✓ (1)
- 1.15 C ✓ (1)
- [15]**

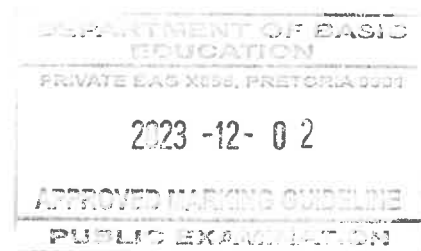

**QUESTION 2: OCCUPATIONAL HEALTH AND SAFETY**

- 2.1
- When any person dies. ✓
  - When the health and safety of any person is endangered. ✓
  - When a major incident occurs.
- NOTE: Only serious injuries are reported to the health and safety inspector.** (2)
- 2.2 Danger means anything that may cause injury to a person ✓ or damage to property. ✓ (2)
- 2.3 The Emergency Master Switch should be located at a key access point ✓ so that in an emergency, workers could access the switch easily. ✓ (2)
- 2.4 Charring of tissue. ✓  
Difficulty in breathing. ✓  
Severe symptoms of shock.  
**Muscle and bone damage.** (2)
- 2.5 Check whether the person is able to breath. ✓  
Send a person to call for medical assistance. ✓  
Keep the person lying down.  
If unconscious, put the person on his/her side. (recovery position)  
Don't move the person in case of neck or spine injuries.  
Cover the person to maintain body heat.  
Keep a close watch on the person's colour, raising the head or legs to manage the blood flow into the paler areas. (2)

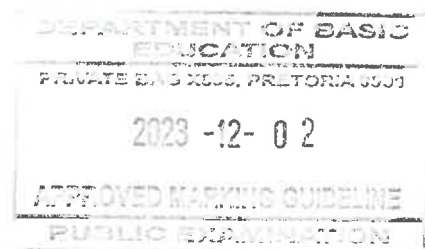
**[10]**

**QUESTION 3: SWITCHING CIRCUITS**

3.1 A bistable multivibrator's output has two stable states ✓ keeping its output in either high or low state when a trigger input is applied. An astable multivibrator's output has no stable state, ✓ it changes between high and low continuously. (2)

3.2 3.2.1 R<sub>1</sub> + R<sub>2</sub> act as a voltage divider ✓ with R<sub>2</sub> that provides positive feedback. ✓ R<sub>2</sub> acts as a voltage divider with R<sub>1</sub> that provides positive feedback and maintains a voltage with the same polarity as the output on the non-inverting input. (2)

3.2.2 Positive ✓ (1)

3.2.3 When S<sub>1</sub> is pressed the circuit output will be negative where it will remain until S<sub>2</sub> is pressed. ✓ When S<sub>1</sub> is pressed, both plates of the capacitor rise forcing the inverting terminal high. Making this voltage greater than the voltage on the non-inverting terminal; the op-amp immediately saturates forcing its output low (-V<sub>SAT</sub>) where it will remain. (1)

3.2.4 When S<sub>1</sub> is pressed a positive voltage will be applied to inverting input of the op-amp ✓ and the output will be at negative saturation. ✓ Because the supply voltage is -9 V the output voltage value will be -9 V. ✓ (3)

3.2.5

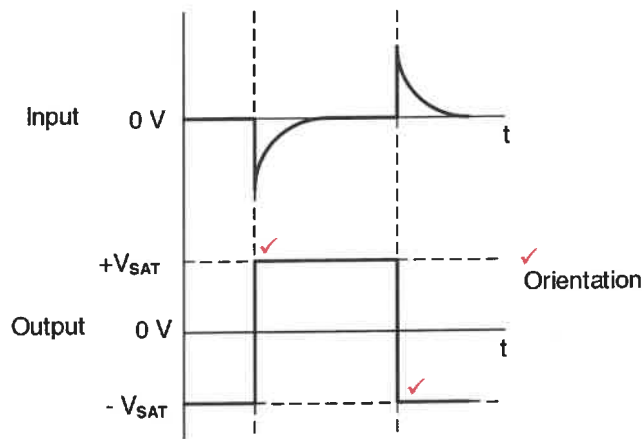

OR

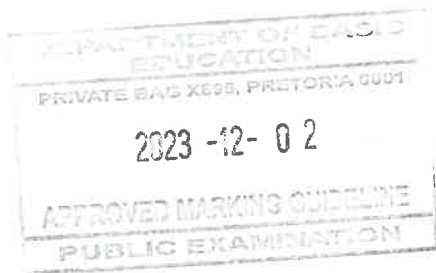
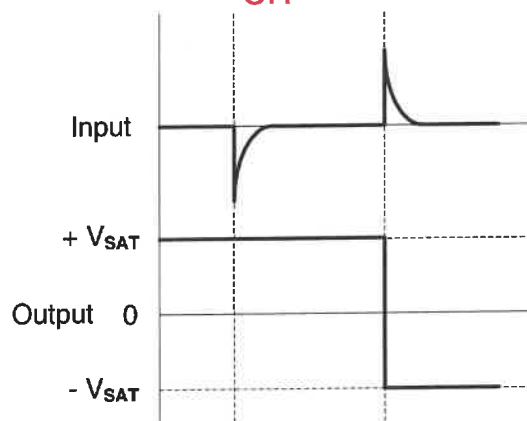

- 3.3 3.3.1 Active low ✓ (1)
- 3.3.2 4 V ✓  
 $\frac{2}{3}$  of the supply voltage (1)
- 3.3.3 When the trigger is pressed, pin 2 is pulled down to 0 V. ✓ This activates the circuit and the capacitor starts to charge through resistor  $R_1$ . ✓ As soon as the voltage across the capacitor reaches  $\frac{2}{3}$  of the supply voltage, ✓ threshold pin 6 will trip/de-activate the internal timing circuit. At the same time both the output pin 3 and discharge pin 7 is pulled 'low' ✓ ending the timing period of the circuit. Capacitor  $C_1$  then discharges through pin 7 and pin 1 to ground ✓ where it is held 'low' until it is triggered again. (5)
- 3.3.4 By connecting a small value capacitor of 0,01  $\mu\text{F}$  ✓ from pin 5 to ground. ✓ (2)
- 3.4 3.4.1 Duty cycle is the time comparison between the high ✓ and low states of a multivibrator output, ✓ usually expressed in percentage. (The percentage/time of a cycle which the output is high)
- Duty cycle is the time comparison between the high state and the period of a multivibrator output. (2)
- 3.4.2 The charging time of the capacitor is longer ✓ because the capacitor charges through  $R_1+R_2$  ✓ and discharges through  $R_2$  only. ✓ (3)

## 3.4.3

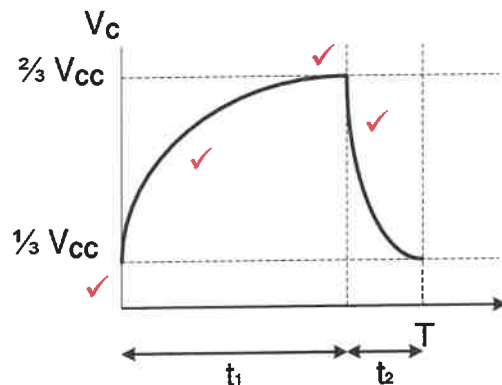

- NOTE: 1 mark for the correct charging cycle starting from  $\frac{1}{3} V_{CC}$ .  
 1 mark for the correct charging signal from  $\frac{1}{3}$  to  $\frac{2}{3} V_{CC}$ .  
 1 mark for the correct discharging voltage from  $\frac{2}{3} V_{CC}$  to  $\frac{1}{3} V_{CC}$ .  
 1 mark for  $t_1$  being longer than  $t_2$ .  
 If the charging starts at 0 and discharges to 0, but everything else is correct 1 mark will be lost. (4)

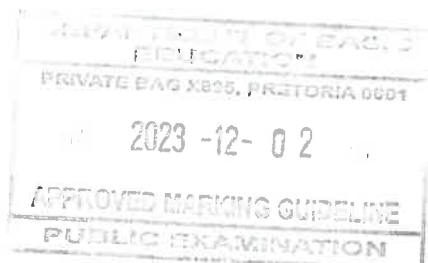

3.5 3.5.1 By making  $R_2$  variable one can vary the trigger voltage levels. ✓  
 By making  $R_2$  variable one can control the fraction of the output that is feedback to the non-inverting input (1)

3.5.2

$$V_{FB} = V_{SAT} \times \frac{R_2}{R_1 + R_2} \quad \checkmark$$

$$= 9 \times \frac{2200}{6800 + 2200} \quad \checkmark$$

$$= 2,2 V \quad \checkmark \quad (3)$$

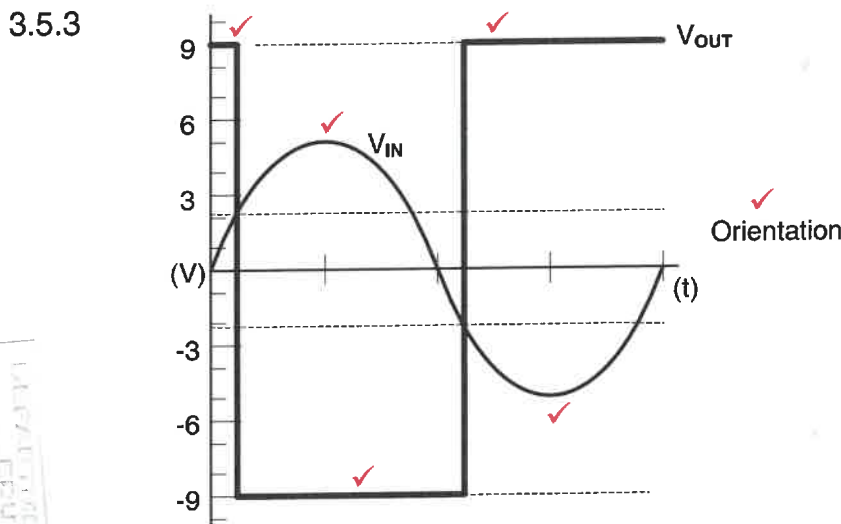

NOTE: If the learner drew an input voltage of 7 V ( $5 V \times 0,707$ ) it will also be considered.

If the learner started the output signal on the 0 line and triggered to the correct saturation value and follows the output exactly as per the memo, only 1 mark will be lost.

NOTE: 2 marks for the input  
 3 marks for the output (2-trigger points, 1 orientation)  
 1 mark for orientation (6)  
 2 marks for orientation (1 input + 1 output)  
 If the learner drew an inverted input with the correct output in relation to the inverted input, full marks will be awarded.

3.5.4 The value of the trigger voltage can be decreased by decreasing the value of  $R_2$ . ✓ (1)

3.6 3.6.1 The capacitors allow only AC to pass to the input and blocks any DC signals from entering the amplifier. ✓ (1)

3.6.2 The variable resistors allow you to control the gain ✓ of each input independently. ✓ (2)

3.6.3

$$V_{OUT} = - \left( V_1 \frac{R_F}{R_1} + V_2 \frac{R_F}{R_2} + V_3 \frac{R_F}{R_3} \right) \quad \checkmark$$

$$= - \left( 0,5 \times \frac{10\,000}{2000} + 0,2 \times \frac{10\,000}{2000} + 0,3 \times \frac{10\,000}{2000} \right) \quad \checkmark$$

$$= -5 V \quad \checkmark \quad (3)$$



3.7

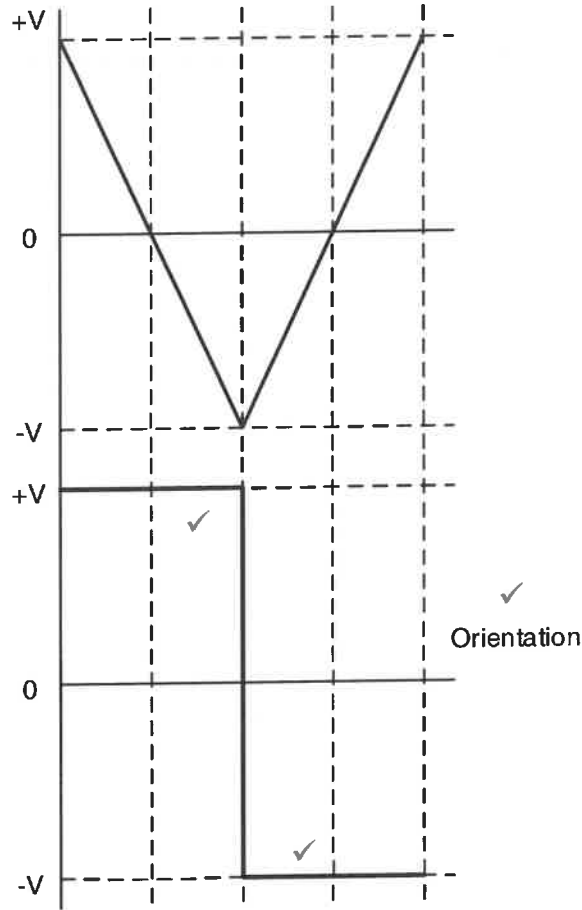

(3)  
[50]

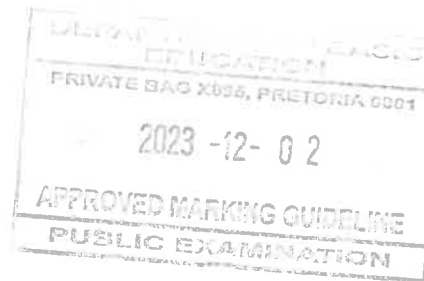



**QUESTION 4: SEMICONDUCTOR DEVICES**

4.1 4.1.1 The feedback resistor is used to reduce the gain of the amplifier to the required level ✓  
Provides negative feedback of the output to the inverting input. (1)

4.1.2 Op-amps are **seldom** used in an open loop mode because of their very high gain ✓ which creates poor stability of the output voltage. ✓ (2)

4.1.3 
$$A_v = -\frac{R_F}{R_{IN}}$$
 ✓  

$$= -\frac{1,2 \times 10^3}{1 \times 10^3}$$
 ✓  

$$= -1,2$$
 ✓ (3)

4.2 4.2.1 It provides the op-amp with dc stability. ✓  
It prevents the op-amp from saturating. ✓ (2)

4.2.2 
$$A_v = 1 + \frac{R_F}{R_{IN}}$$
 ✓  

$$= 1 + \frac{120\ 000}{10\ 000}$$
 ✓  

$$= 13$$
 ✓ (3)

OR

$$A_v = -\frac{R_F}{R_{IN}}$$

$$= -\frac{120\ 000}{10\ 000}$$

$$= -12$$

NOTE: With the swopping of the symbols on the diagram provided the calculation of the inverting op-amp gain will also be considered.

4.3 4.3.1 Timer ✓  
Oscillator ✓  
Multi-vibrator  
Schmitt trigger  
Temperature measurements  
Control servo devices  
Digital logic probes  
Create warning lights  
Produce musical notes

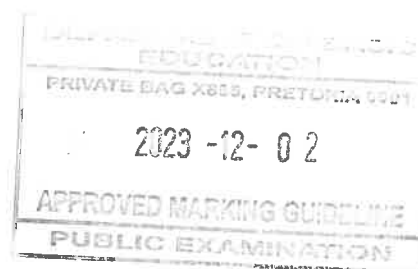

(2)

## NSC – Marking Guidelines

- 4.3.2
- They cannot cope with high currents, high voltage or high power requirements. ✓
  - They can be damaged by overloading or by fluctuating power supplies. ✓
  - Current limitation of 200 mA
  - Voltage limitation of 18 V
- (2)
- 4.3.3
- Pin 4 is the reset input for the flip-flop and as soon as the reset pin is set to 0 V ✓, the output pin 3 ✓ and the discharge pin 7 will be connected to 0 V ✓ resetting the IC.  
(The reset pin 4 is used to reset the IC i.e it causes the output to return to zero volts if it is connected to zero volts).
- (3)
- 4.3.4
- (a) The NPN transistor provides a low resistance path for discharge current to flow from Pin 7 to ground ✓ only when the flip-flop goes high.
- (1)
- (b) Comparator 2 compares lower voltage ( $\frac{1}{3}V_{CC}$ ) against the trigger voltage. ✓
- (1)
- [20]



**QUESTION 5: DIGITAL AND SEQUENTIAL DEVICES**

5.1 5.1.1 In common anode the anodes of all the LEDs are connected on the positive voltage rail. ✓  
In common cathode all the LED cathodes are internally connected to a common 0 V/ground. ✓ (2)

5.1.2 Sinking output circuit ✓  
Sourcing output circuit ✓ (2)

5.2 5.2.1  $X = +5\text{ V}$  ✓  
 $Y = 0\text{ V}$  ✓ (2)

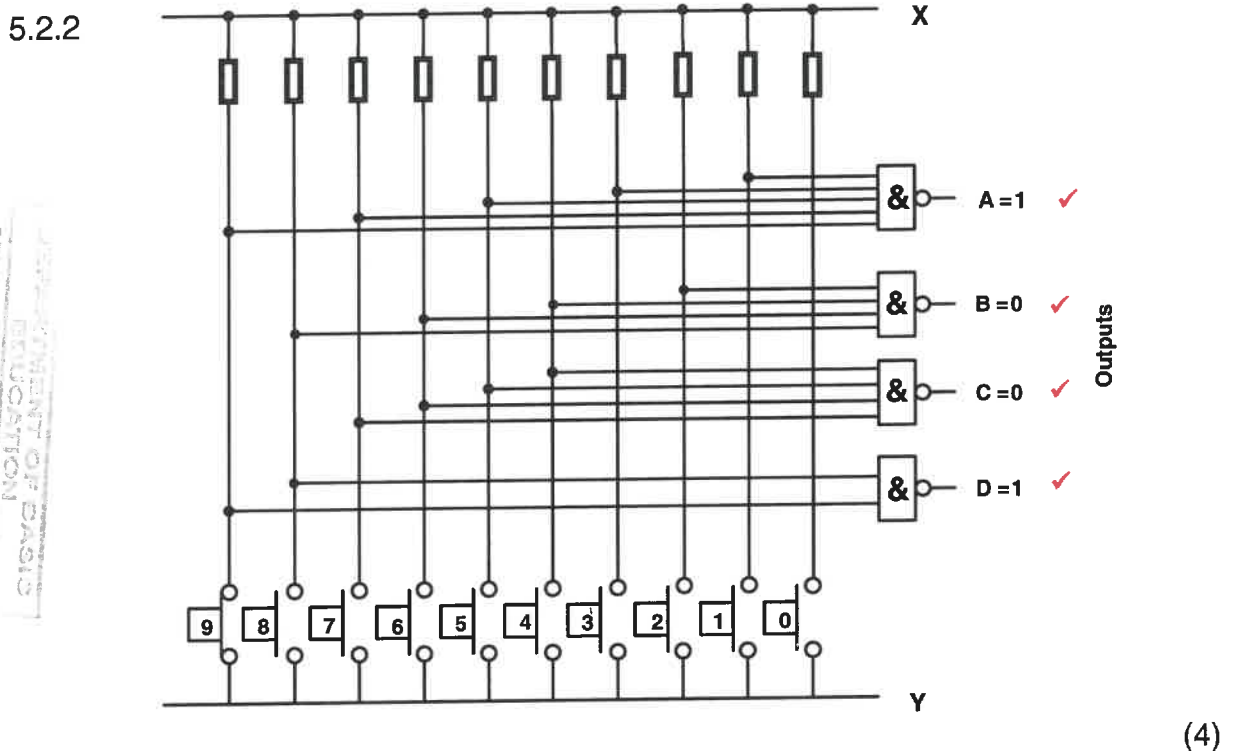

5.3

- An LCD is constructed with thousands of picture elements, called pixels.
- These pixels are aligned in an array of neat rows and columns across the screen. ✓
- The screen is back-lit through an array of LED's and filters to create a uniform level of light where the LCD pixel elements can be seen. ✓
- Each pixel in the matrix array is controlled by its own thin-film transistor, energising each pixel by turning voltages on or off to the liquid-crystal pixel. ✓
- This transistor array requires careful control for them to turn their pixels on and off at the correct times to form a coherent picture on the LCD's screen. ✓

(4)

OR

- A second LCD-unit that is pixelized over the entire area are added to the back of the 7-segment LCD-display filament.
- When the contrast between the characters and the background must be increased the voltage to the pixelized LCD-unit is decreased and the LCD-crystals will line up with the polaroid filter and let more light through thus the characters will be more visible.
- When you want less contrast between the characters and the background the voltage to the pixelized LCD-unit will be increased thereby changing the alignment of the liquid crystals to filter more reflecting light out and the screen would appear darker.

5.4

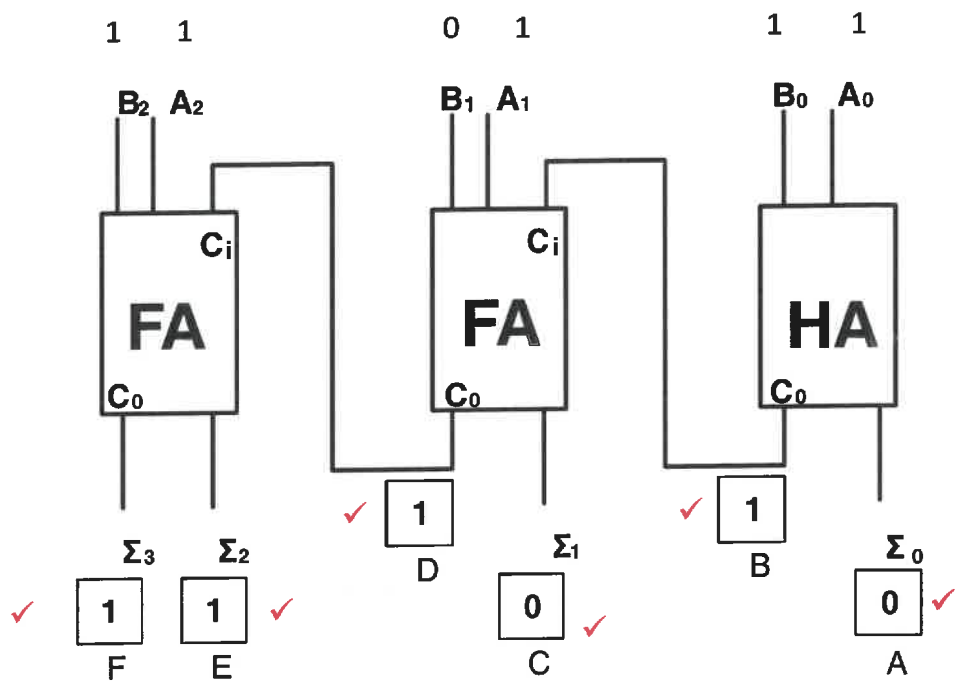

(6)

5.5

5.5.1

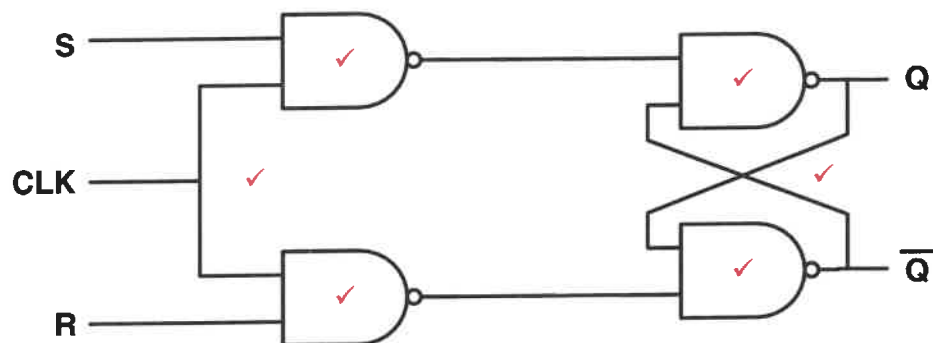

NOTE: 1 mark for each correctly placed NAND gate = 4  
1 mark for each correct connection = 2

(6)

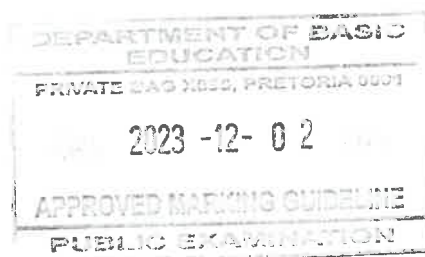

5.5.2

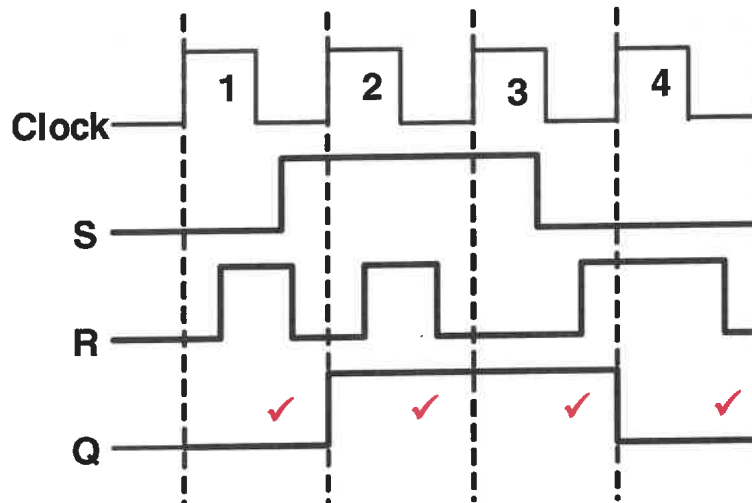

(4)

5.6 A decoder converts a binary code ✓ into a recognisable decimal form, ✓  
either as a digit or a character. (2)

5.7 5.7.1 RS-Latch ✓  
Active low RS latch  
Active high RS latch (1)

5.7.2 Gated RS-latch ✓  
D-type flip-flop  
JK Flip-flop  
Clocked RS flip-flop (1)

5.8 5.8.1 Negative edge triggering occurs when the circuit reacts to the  
falling edge of the pulse ✓ which falls from logic '1' to logic '0'. ✓ (2)

5.8.2 Propagation delay is where the timing signal is delayed ✓ a fraction  
through each flip-flop. ✓ (2)

5.9 5.9.1 A counter that runs to its maximum count. ✓ (1)

5.9.2 A counter that is modified to stop its count before reaching its  
maximum count. ✓ (1)

5.10 5.10.1 Up/Down counter ✓ (1)

5.10.2

- When the input is set to high it will enable the two upper AND gates once each one of them receive a high from either FF0 or FF1 outputs. ✓
- The AND gate between FF0 and FF1 will pass the high output ✓ from Q<sub>0</sub> to J and K inputs of FF1. ✓
- The output Q<sub>1</sub> of FF1 will enable the second AND gate to pass a high ✓ through to the J and K inputs of FF2. ✓
- The circuit then operates as a synchronous 'Up' counter. ✓ (6)

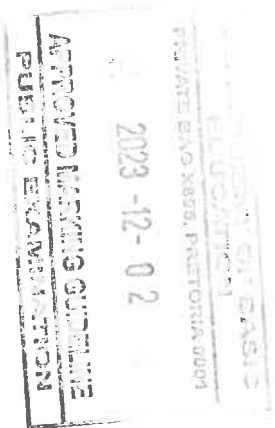

- 5.11 5.11.1 Parallel - In: Parallel-out ✓ shift register (1)
- 5.11.2 A = 4-bit Parallel Data Input ✓  
B = Clock / Clear ✓  
C = 4-bit Parallel Data Output ✓ (3)
- 5.11.3 Temporary storage device ✓  
Time delay device (1)
- 5.11.4 Data is introduced in a parallel format to the inputs of the D-type flip-flops ✓  
and transferred through to the output pins by the same clock pulse. ✓  
So one clock pulse is needed to load and unload the register. ✓ (3)
- [55]

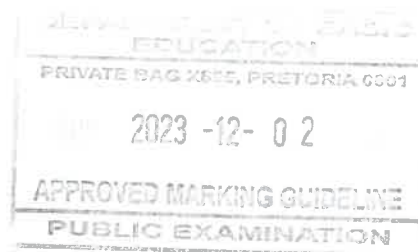

**QUESTION 6: MICROCONTROLLERS**

- 6.1 A device that has program memory on the chip containing essential elements ✓ to function as a microcontroller. ✓ (2)  
The on-board memory of an embedded device, that contains all the necessary components to function, such as a microcontroller, where data and program information are stored.
- 6.2 6.2.1 A = PC (Programme Counter) ✓  
B = ALU (Arithmetic Logic Unit) ✓  
C = IR (Instruction Register) ✓ (3)
- 6.2.2 The MAR stores the address ✓ of the next instruction ✓ to be executed by the processor. (2)
- 6.2.3 The data bus transfers all data, ✓ which is sent and received, between CPU, memory and both input and output ports. ✓ (2)
- 6.2.4 The RAM is a temporary memory bank where the computer stores data ✓ that is required to be retrieved quickly. ✓ (2)
- 6.2.5 RAM is known as volatile memory as it loses all data stored ✓ when the system's power is turned off. ✓ (2)
- 6.3 A/D converters are used in microcontrollers to detect ✓ an analogue signal and convert it to a digital format which the CPU can interpret. ✓ (2)
- 6.4 6.4.1 A set of rules and regulations ✓ that allow two electronic devices to connect and to exchange data and information ✓ between each other. (2)
- 6.4.2 Simplex ✓  
Duplex ✓ (2)
- 6.5
- | SPI                | I <sup>2</sup> C    |
|--------------------|---------------------|
| Full duplex ✓      | Half duplex         |
| Four-wire protocol | Two-wire protocol ✓ |
| Single master      | Multiple masters ✓  |
- (3)
- 6.6 6.6.1 A = Data bus ✓  
B = Control Input/Output ✓ (2)
- 6.6.2 The UART has one start bit, ✓ eight data bits, ✓ one parity bit ✓ and one stop bit. ✓ (4)

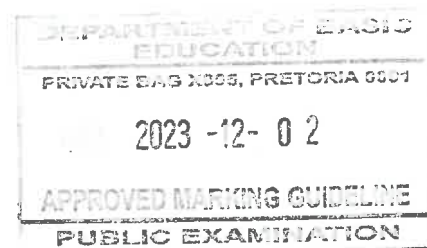

- 6.6.3
- Useful for communicating serial data ✓
  - Easy and low-cost serial interface connection between two computer systems ✓
  - The industrial standard for asynchronous data communication interfaces.
  - Reliable for high-speed serial communication.
  - Uses far fewer wires than parallel communications.
  - Enables long distance communications.

(2)

6.7

CHARACTERISTICS	RS-232	RS-485
Line configuration	Single-ended	Differential
Maximum cable length	15 metres	1 200 metres
Typical logic levels	±3 to ± 25 V	±200 mV ✓
Mode of operation	Simplex ✓ OR Half duplex	Simplex ✓ OR Half duplex OR Full duplex

(3)

6.8

- Algorithm is a precise set of procedures to be followed. ✓
- Flow chart is a pictorial version of the algorithm. ✓

(2)

6.9

- The flow of data should be from left to right and from top to bottom. ✓
- Use straight horizontal and vertical connecting lines. ✓
- Keep all steps and instruction as simple as possible. ✓

(3)

6.10

The I<sup>2</sup>C system operates on a naturally low 0 V protocol. ✓ The SCL and SDA lines remain low and need pull-up resistors connected to +5 V in order to go high. ✓

(2)

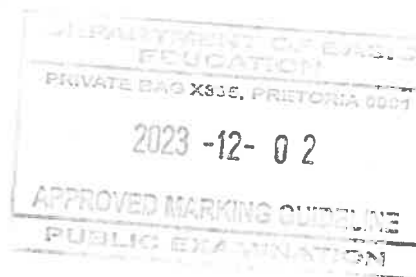



6.11

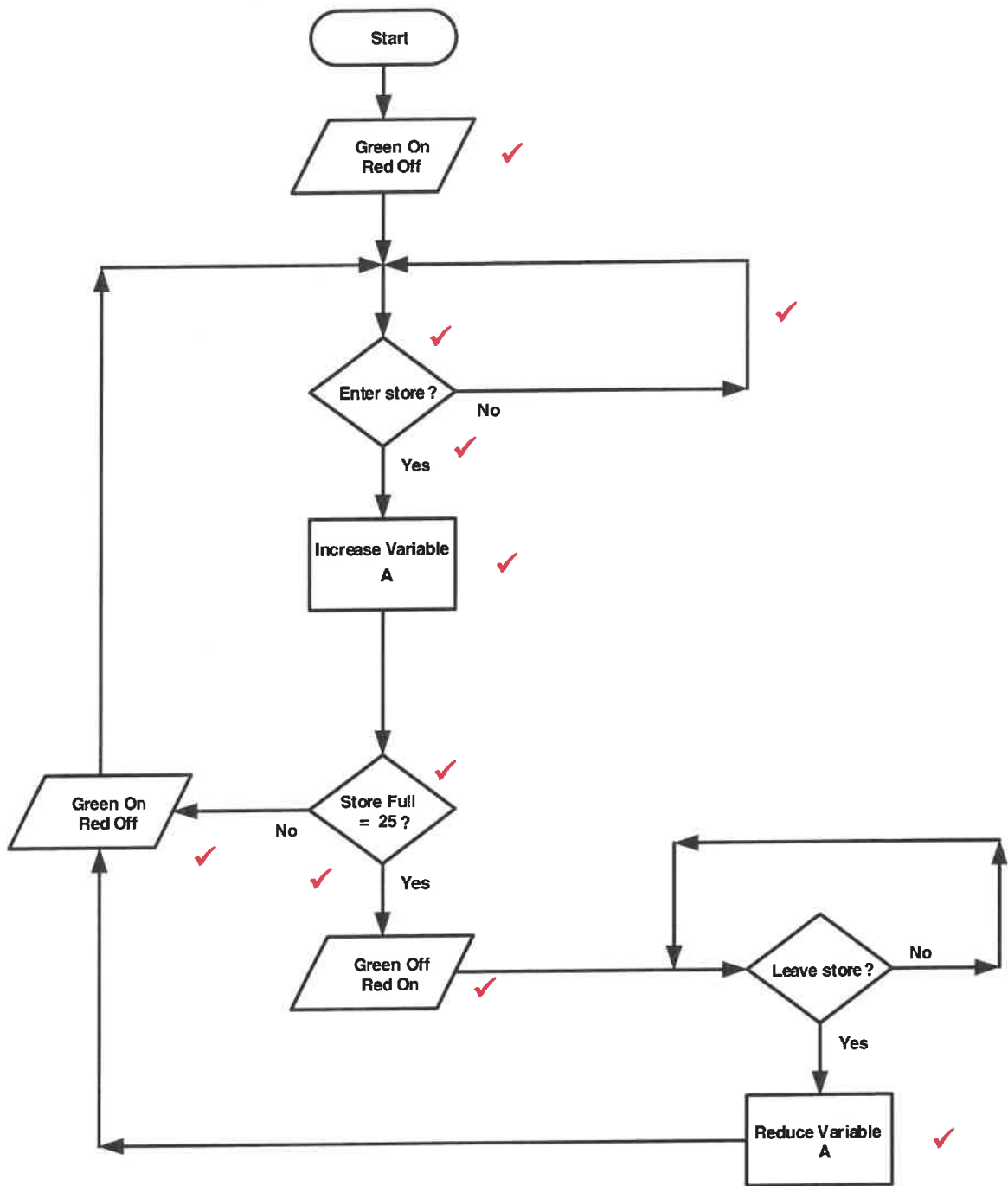

NOTE: 1 mark for each correct labelled symbol = 7  
 1 mark for each correct connection = 1  
 1 mark for each correctly placed Yes/No = 2

(10)  
[50]

TOTAL: 200

